

User Manual

Thank you for choosing our infrared sauna

Congratulations on purchasing the infrared Sauna. Please take the time to carefully read through this manual. Keep this manual and your proof of purchase for future reference and service calls.

Table of Content

TABLE OF CONTENT	2
ELECTRICAL REQUIREMENTS	3
POWER PLUGS.....	3
INSTALLATION INSTRUCTIONS	3-26
CAUTION.....	4
CONNECTING THE PANELS:.....	4-5
WHERE TO START:.....	6
INSTALLATION SET A – GENERAL GUIDE:.....	7-11
INSTALLATION SET B – CORNER MODELS:.....	112 -16
INSTALLATION SET C – 4-PERSON SAUNAS:.....	17-21
INSTALLATION SET D – OUTDOOR SAUNAS:.....	22-24
ACCESSORIES.....	24-26
CONTROL PANEL OPERATION INSTRUCTIONS	27-27
USAGE GUIDE	30-29
PRECAUTIONS.....	30
CLEANING AND MAINTENANCE.....	319
SAUNA’S BENEFITS	31-31
HEALTH BENEFITS.....	31-31
SAUNAS AND CONTRAINDICATIONS	31-33
TROUBLESHOOTING	34-35
WARRANTY INFORMATION	35-38

Electrical Requirements

Each sauna will require a dedicated circuit when plugged in an outlet according to the chart below. A dedicated circuit requires that no other appliance should share the outlet/circuit with the sauna. Failure to comply with this requirement may cause electrical interruption and diminished performance. It is recommended that a qualified electrician install your dedicated electrical wiring for proper sauna functionality and to avoid any potential electrical hazards. Please make sure the sauna is properly grounded. Serious injury may result if proper electrical requirements are not met.

Please follow all instructions carefully. Keep the sauna away from any potential hazards including any water source or liquids. Select a dry suitable location for the sauna installation. Do not expose the heater elements to any water source or liquids as it may cause electrical shock. Should you have any questions, please do not hesitate to contact the supplier

Power Plugs

European Plug



American plug



British plug

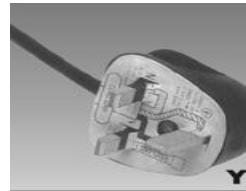

Installation Instructions

Please read the following directions carefully. The sauna installation requires a minimum of 2 people. You should not try to install the sauna on your own as damage will easily occur.

Caution

- 1- No plumbing or plumbing fixtures should be placed in the sauna.
- 2- Keep all liquids away from the heating panels
- 3- Install the sauna on a completely level surface.
- 4- Install the sauna in an area that is dry and protected from the weather.
- 5- Flammable objects and corrosive chemical substances should be kept far away from the sauna.

Your infrared sauna will come packaged in three boxes. Please make sure that you open the boxes face up. Please be very careful when opening boxes, due to fragile parts and glass.

Connecting the Panels:

The **Sauna** offers two types of panels locking system to connect the different sides of the sauna. Please use the instructions below as a reference guide on how to connect the sauna panels.

Inner Locking System:

The inner locking system is designed to be completely invisible when the sauna is installed. The locks are built on the side of each panel and they connect by sliding one over the other (Figure G-2).

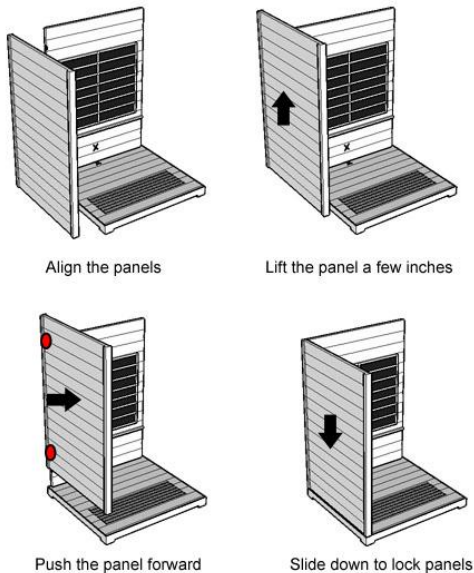

Figure G-1: Connect panels, inner lock system

To connect two panels, follow these few steps:

1. Lift the panel with the male locks a few inches.
2. Push it against the opposite panel; make sure to apply pressure around the top and bottom corners.
3. Slide the panel down to lock it in place. Make sure all the locks are connected (top and bottom).
4. Inspect the panels and make sure they are leveled (the panels top is flat and matching).

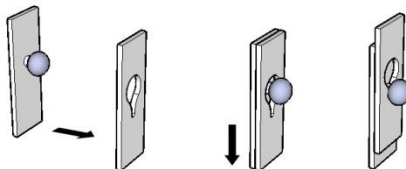

Figure G-2: Inner Locking System

Latch System:

The Latch Locking System is two brackets that lock together by passing the main loop over the opposite side and locking the latch (Figure G-3).

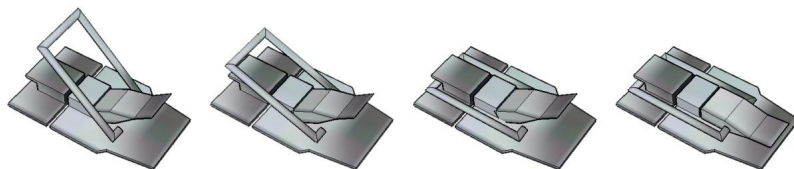

Figure G-3: Latch Locking System

Where to Start:

Lay the boxes flat on the ground and open them carefully. The accessories, user manual and smaller parts are located under the dust cover - the box that includes the top and bottom panels (Figure G-4).

(Note:some model without dust cover)

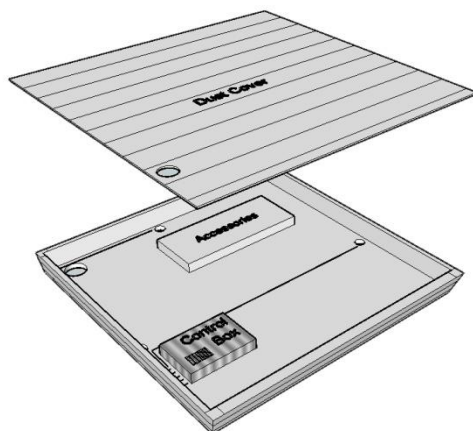

Figure G-4: Remove the Dust Cover to uncover accessories

Installation Set A – General Guide:

The following installation instructions apply to following models:

- 1-Person, 2-Person and 3-Person saunas (indoor and outdoor models.
- 4-Person Family saunas

Floor Panel Place the floor panel flat on the desired location. Make sure to leave a space around the side walls for one person to stand and install the side panels (Figure A-1). You can slide the sauna once it's complete next to a wall.

Tips:

- An "X" mark will point to the back of the sauna and the floor heater (on some models) point to the front of the sauna.

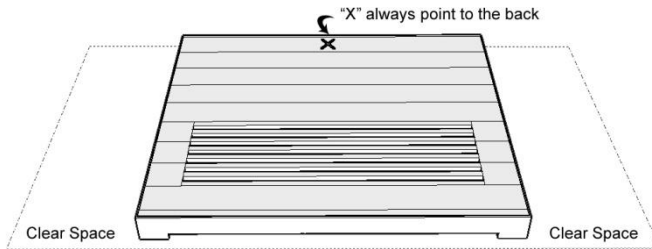

Figure A-1: Floor Panel

Rear Panel

Place the rear panel on the back end of the floor panel (Figure A-2). At this point, someone should hold the rear panel until the next connection is made.

Left Panel

Install the left panel (the left panel has 2-4 sockets on the lower end) as the image below. Make sure the top of both panels is flat and leveled.

Refer to "Connecting the Panels" section (page 4) on how to lock the panels together.

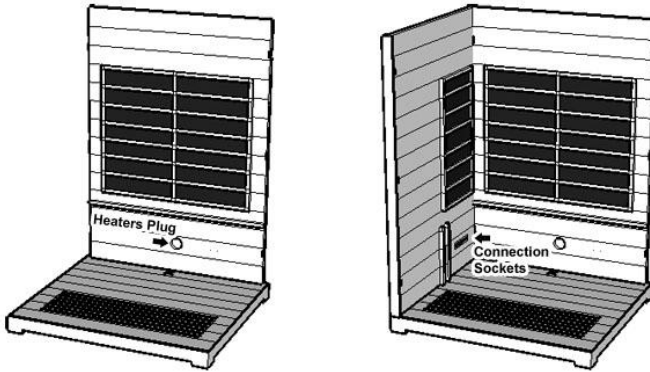

Figure A-2: Rear and left panels

Bench Installation

Slide the bench stand panel between the two vertical guides on the side panels. Connect the heaters' plugs under the bench to the appropriate sockets. The matching plugs and sockets are labeled alphabetically – e.g. connect “A” plug into the “A” socket.

Install the bench top by placing it on top of the bench stand and the horizontal guide on the rear panel. Make sure the smooth and finished side is facing up and forward (Figure A-3).

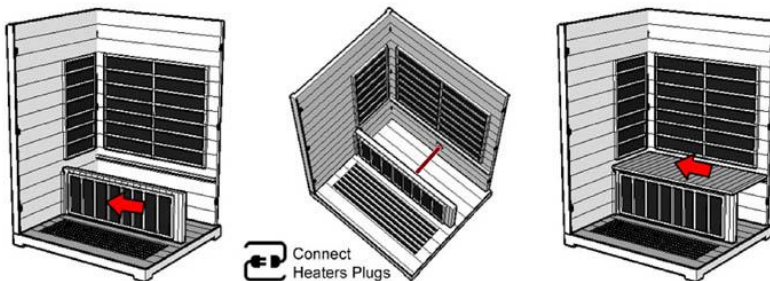

Figure A-3: Installing the Bench

Right Panel

Install the right panel as the image below (Figure A-4). Make sure the top of all the panels is flat and leveled.

Refer to “Connecting the Panels” section (page 4) on how to lock the panels together.

Tip:

- Someone can stand inside the sauna to match the bench stand with the vertical guide on the right panel and level the corners for easy installation. If the lower lock is not connecting, make sure the bench stand is not blocking the panel by aligning it with the vertical guide.

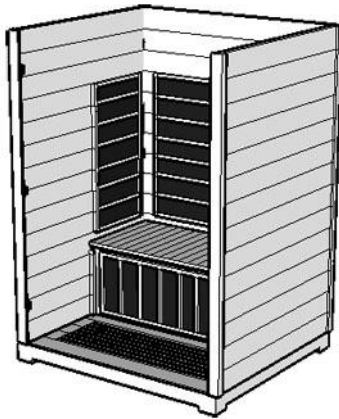

Figure A-4: Right Panel

Important:

Install the door handle at this point, before installing the front panel.

Front Panel

Install the door handle before installing the front panel.

Connect the front panel to both side panels as in the image below (Figure A-5).

Refer to “Connecting the Panels” section (page 4) on how to lock the panels together.

Tips:

- Make sure to align the corners of the two side panels and the edges of the front panel.
- The front panel is heavy because of the glass door. At least two people are needed to lift it.
- For inner locking system, a person can stand inside the sauna to align the edges and corners of the panels.
- For inner locking system, make sure to put pressure on the top and bottom corners of each side to insure the locks are connecting.

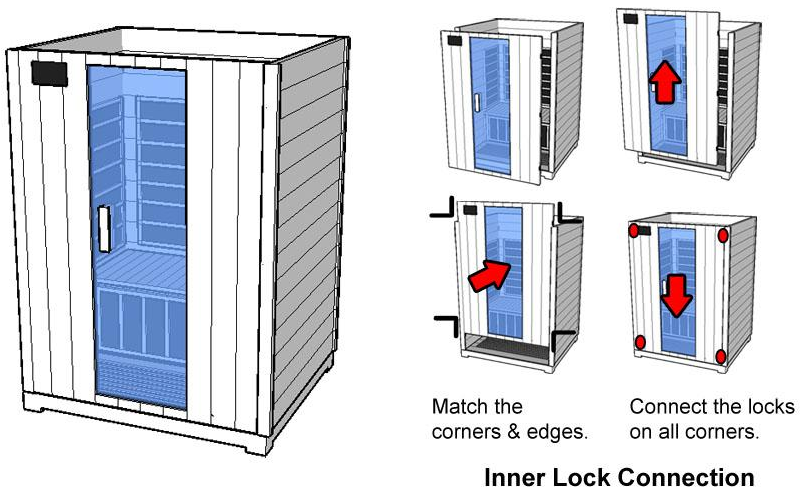

Figure A-5: Front Panel

Top Panel

Raise the top panel over the sauna body. Insert the wires for the control panel, temperature sensor and heaters through the openings in the ceiling.

Connect the control panel wire (white ribbon) and the heat sensor (2-pin wire) on top of the sauna.

Connect the heaters' plugs into the control box. Even though the heaters' plugs might be labeled, they can connect into any sockets on the control box (Figure A-6).

Place the dust cover over the sauna roof and pass the main power plug through the opening. Make sure to match the holes for the vent on the dust cover with the saunas vent holes.

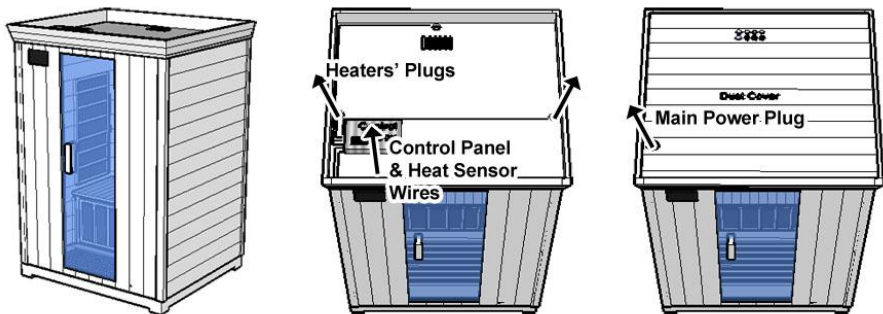

Figure A-6: Top Panels and Connections

Outdoor models installation instructions continue in Installation Set-D.

Accessories installation instructions continue below the outdoor models.

Installation Set B – Corner Models:

Please review the rectangular models installation steps for general information.

Floor Panel

Place the floor panel flat on the desired location. Make sure to leave a space around the side walls for one person to stand and install the side panels (Figure B-1). You can slide the sauna once it's complete next to a wall.

Tips:

- The triangle corner will point to the back of the sauna and the heater (on some models) point to the front of the sauna.

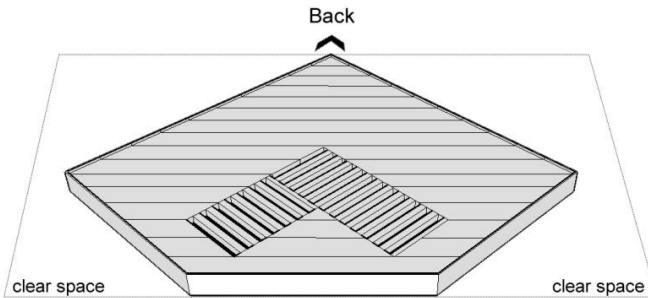

Figure B-1: Floor Panel

First Back Panel

Place the first back panel on the floor panel (Figure B-2). At this point, someone should hold the back panel until the next connection is made.

Tips:

- The first panel will have female locks on both sides.

Second Back Panel

Connect the second back panel to the first panel as the image below (Figure B-3).

Refer to "Connecting the Panels" section (page 4) on how to lock the panels together.

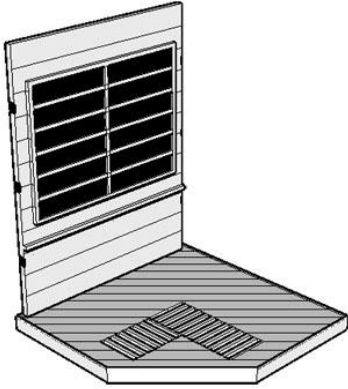

Figure B-2: First Back Panel

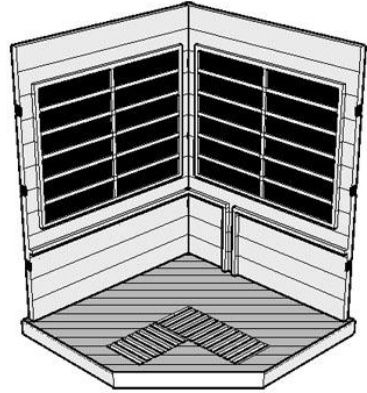

Figure B-3: Second Back Panel

Front Sides

Install the two front side panels (Figure B-4).

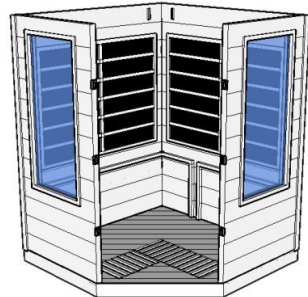
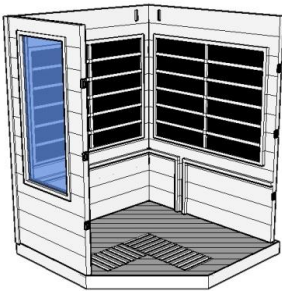
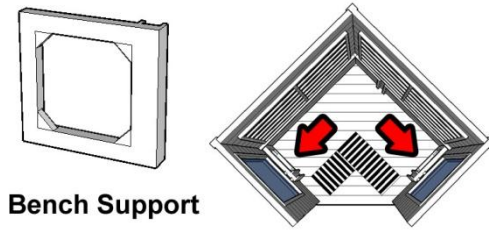

Figure B-4: Installing the front panels

Benches

Some saunas will include a square bench support. Place it in front of the windows (Figure B-5).



Bench Support

Figure B-5: Bench Support

Place the bench stand panels by lining up its side with the vertical guides on the back panels. Connect the heaters' plugs to under the bench and slide the bench panel over the horizontal guide on the back panels. Make sure the smooth and finished side is facing up and forward (Figure B-6).

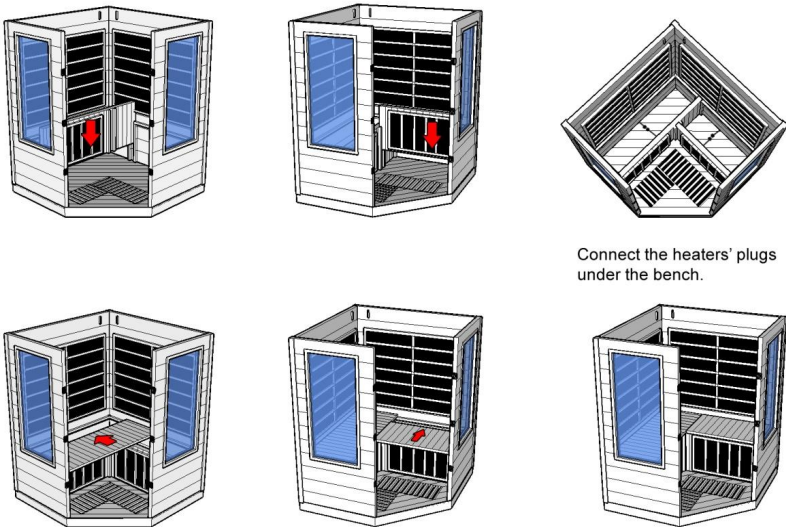

Connect the heaters' plugs under the bench.

Figure B-6: Bench Installation

Door Panel

Install the door handle first.

Connect the door panel to the front side panels. For the inner lock system, make sure to match the edges of the front panels to the corners of the door panel (Figure B-7).

Tips:

- The front panel is heavy because of the glass door. At least two people are needed to lift it.
- For inner lock system, a person should stand inside the sauna to align the corners and edges of the panels.
- For inner locking system, make sure to put pressure on the top and bottom corners of each side to insure the locks are connecting.

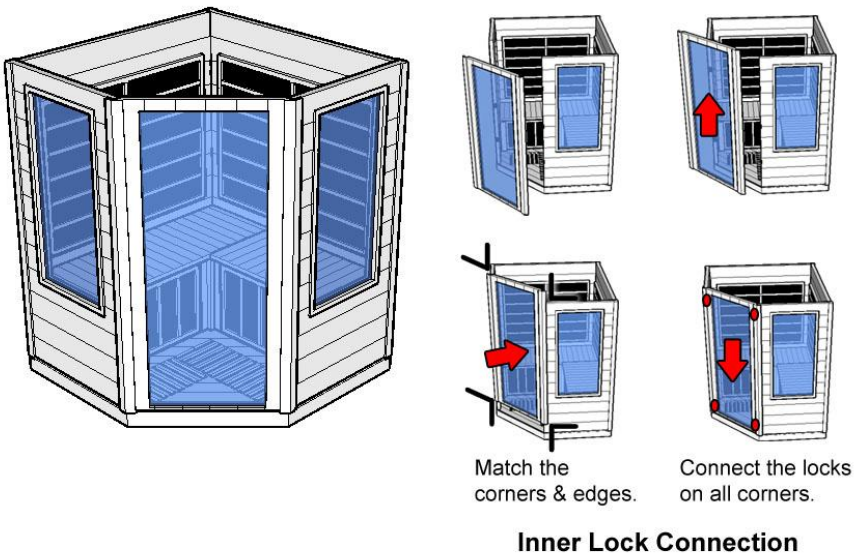

Figure B-7: Front Panel

Top Panel

Raise the top panel over the sauna body. Insert the wires for the control panel, temperature sensor and heaters through the openings in the ceiling.

Connect the control panel wire (white ribbon) and the heat sensor (2-pin wire) on top of the sauna.

Connect the heaters' plugs into the control box. Even though the heaters' plugs might be labeled, they can connect into any sockets on the control box (Figure B-8).

Place the dust cover over the sauna roof and pass the main power plug through the opening. Make sure to match the holes for the vent on the dust cover with the saunas vent holes.

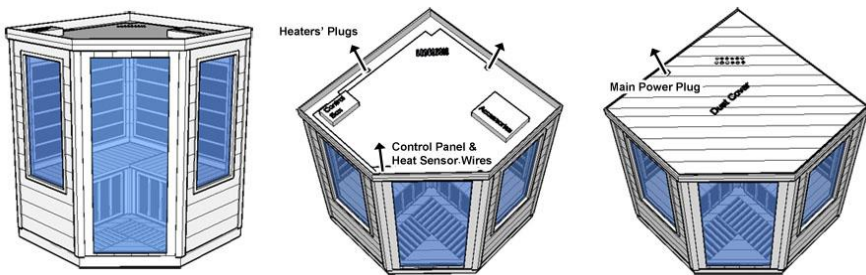

Figure B-8: Top Panels and Connections

Accessories installation instructions continue below the outdoor models.

Installation Set C – 4-Person Saunas:

The following installation instructions are for the following models:

- 4-Person
- Follow the “Installation Set A” for 4-Person Family Saunas
- Floor Panel

Place the floor panel flat on the desired location. Make sure to leave a space around the side walls for one person to stand and install the side panels (*Figure C-1*). You can slide the sauna once it’s complete next to a wall.

Tips:

- An “X” mark will point to the back of the sauna and the heater (on some models) point to the front of the sauna.

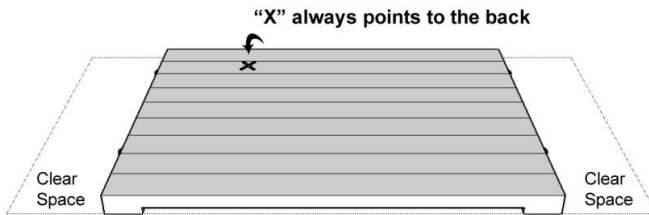

Figure C-1: Floor Panel

Rear Panel

Place the rear panel on the back end of the floor panel. At this point, someone should hold the rear panel until the next connection is made.

Side Panels

Connect the side panels to the back panel as in the image below (*Figure C-2*). Refer to “Connecting the Panels” section (page 4) on how to lock the panels together.

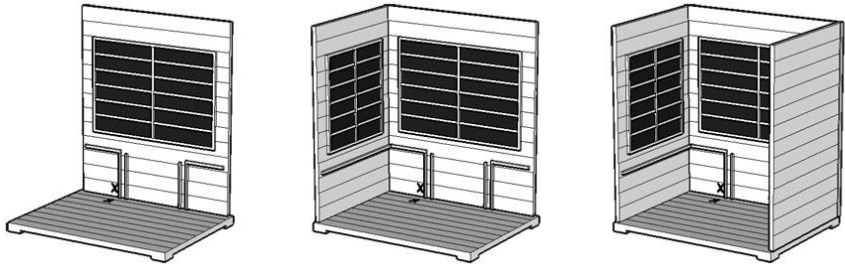

Figure C-2: Rear and Side Panels

Bench

Some saunas will include a square bench support. Place it in front of the windows (Figure C-3).

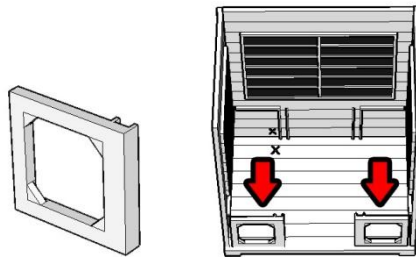
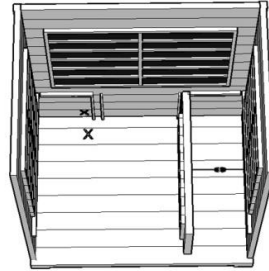
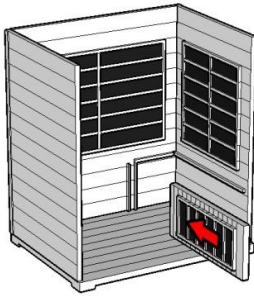

Figure C-3: Bench Support

Place the bench stand panels by lining up its side with the vertical guides on the rear panel. After placing the bench stand panel, connect the heaters' plugs.

Slide the bench top panel over the horizontal guide on the side panels. Make sure the smooth and finished side is facing up and forward (Figure C-4).



Connect the heaters' plugs under the bench.

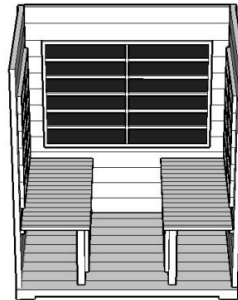
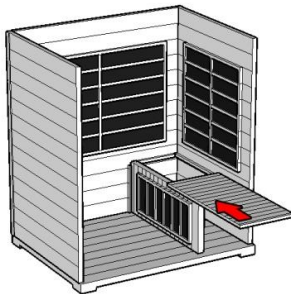

Figure C-4: Installing the Bench

Important:

Install the door handle at this point, before installing the front panel.

Front Panel

Install the door handle before installing the front panel.

Connect the front panel to both side panels as in the image below (Figure C-5). Refer to "Connecting the Panels" section (page 4) on how to lock the panels together.

Tips:

- Make sure to align the corners of the two side panels and the edges of the front panel.
- If the lower locks are not connecting, make sure the bench stand is not blocking the panel by aligning it with the vertical guide.
- The front panel is heavy because of the glass door. At least two people are needed to lift it.
- For inner locking system, a person can stand inside the sauna to align the edges and corners of the panels.
- For inner locking system, make sure to put pressure on the top and bottom corners of each side to insure the locks are connecting.

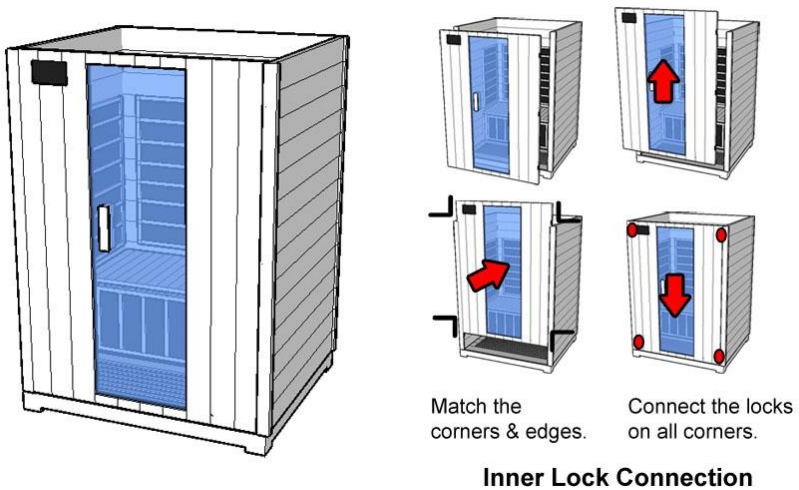

Figure C-5: Front Panel

Top Panel

Raise the top panel over the sauna body. Insert the wires for the control panel, temperature sensor and heaters through the openings in the ceiling.

Connect the control panel wire (white ribbon) and the heat sensor (2-pin wire) on top of the sauna.

Connect the heaters' plugs into the control box. Even though the heaters' plugs might be labeled, they can connect into any sockets on the control box (Figure A-6).

Place the dust cover over the sauna roof and pass the main power plug through the opening. Make sure to match the holes for the vent on the dust cover with the saunas vent holes.

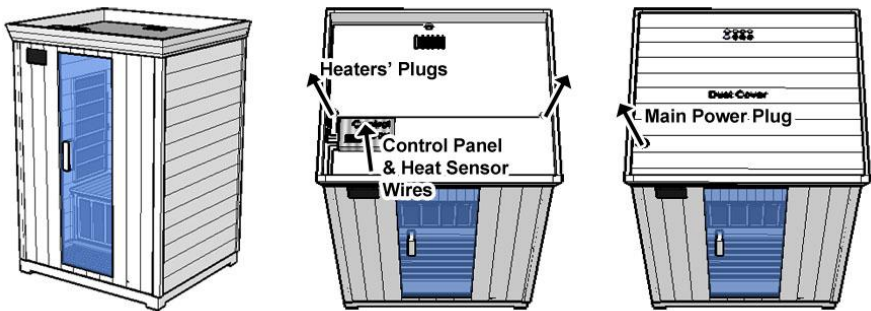

Figure A-6: Top Panels and Connections

Accessories installation instructions continue below the outdoor models.

Installation Set D – Outdoor Saunas:

Installation steps start at section “Installation Set A”. Continue after placing the top panel.

Main Support

Place the roof bottom section on top of the sauna and screw the center support beam (Figure D-1).

The illustration below will not include the sauna’s body, but the roof should be installed on top of the sauna.

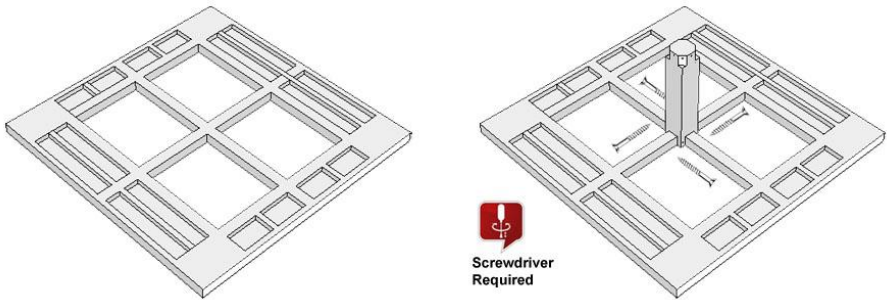

Figure D-1: Roof bottom section and center support beam

Roofing Shingles Support

Install the roofing shingles support beams around the top. Each beam is labeled alphabetically to a matching corner or side (Figure D-2). For example, the beam marked with “A” should be screwed into the “A” corner. Repeat for all the corners and sides (based on the model, you might have eight or six supporting beams).

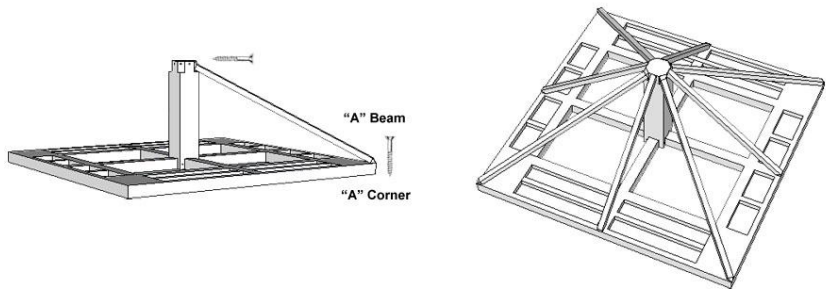

Figure D-2: Shingles Support Beams

Screw the triangular roofing shingles on the supporting beams (Figure D-3). Repeat for all sides.

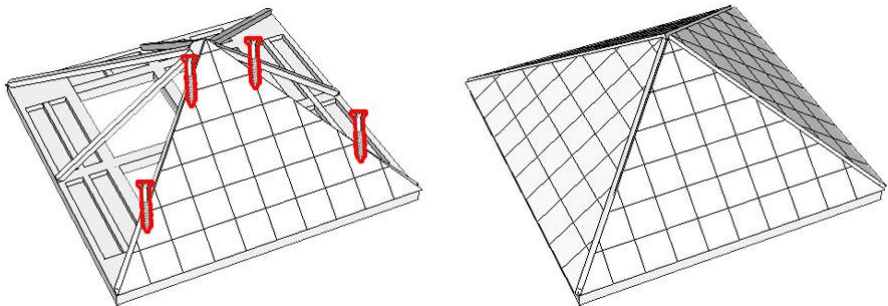

Figure D-3: Roofing Shingles

Roof Sealing

Screw the corner roof shingles around all corners. Each corner will have two shingles curved upward to easily identify the screws position (Figure D-4).

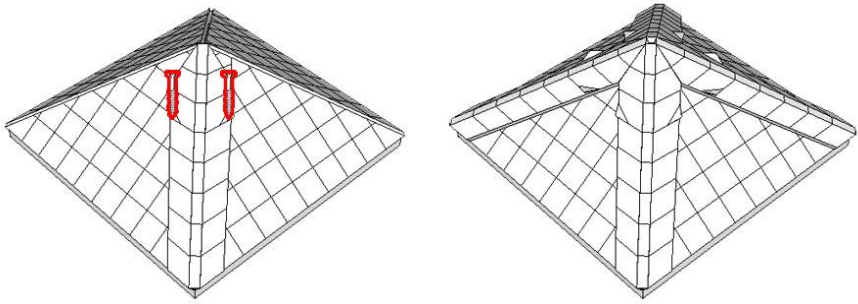

Figure D-4: Corner Roof Shingles

After screwing the corners, flatten the curved shingles and place the pyramid roof shingles on the top (Figure D-5).

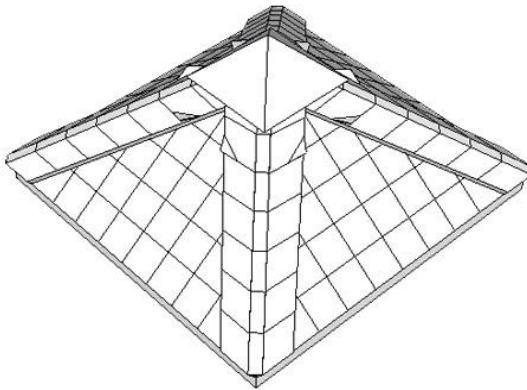

Figure D-5: Pyramid Roof Shingles

Accessories

Oxygen Ionizer

Locate the ionizer plug that is extended out of the sauna ceiling (1-pin plug). Connect the oxygen ionizer and screw it on the back panel.



The oxygen ionizer is used to refresh the air inside the sauna by killing odor causing bacteria and removing airborne particles.

Use:

Before and while using the sauna, please select the “Ion” option to remove airborne particles by attaching them to the ionizer. After using the sauna, select the “O3” option to kill odor causing bacteria out of the sauna air.

Cup Holder (optional)

The cup holder is a small wooden table that can be screwed in one of the front corners (either right or left, based on the user preference). Make sure not to install the cup holders on or in front of the heaters.

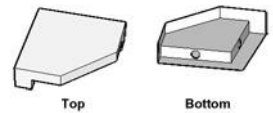

Some models with glass front or corner saunas will not include the cup holder.

Magazine Holder (optional)

The magazine holder can be installed either on the front wall (in front of the window) or in the side wall (next to the legs) (the placement of the magazine holder is optional based on the user preference). Do NOT install the magazine holder in front of the heaters. The magazine holder size might vary based on the model.



Towel Rack (optional)

For models with full glass doors, the towel rack can be installed either on the front wall or in the side wall (the placement of the towel rack is optional based on the user preference). Do NOT install the towel rack in front of the heaters.



For models with glass and wooden frame doors or wooden doors, install the towel rack on the middle of the door frame and use it as a door handle.

Color Therapy Lights (options)

Some models will include color therapy lights (or chromo lights). The color lights are operated by the remote control only. Press any color on the remote control to turn the lights on and select a color. Press the “Cycle” button (lower right button) to cycle through the colors randomly. Press the “Power” button to turn the lights off.



Control Panel Operation Instructions

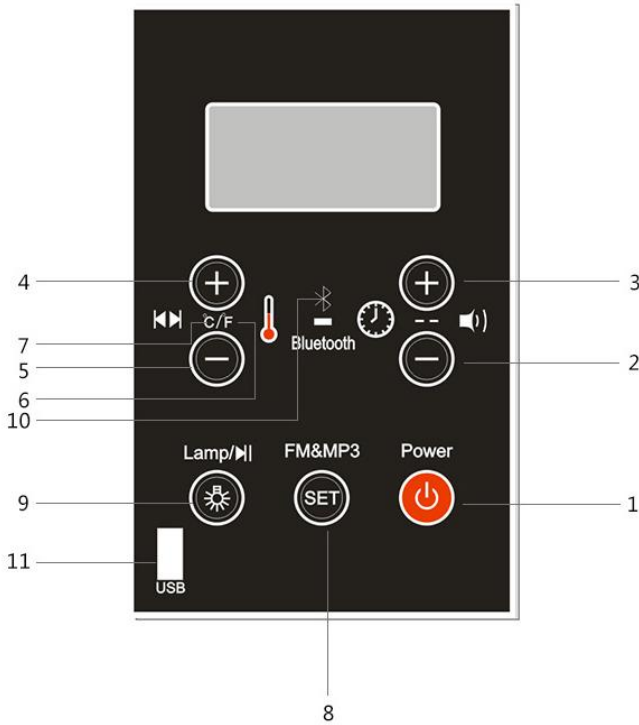

NO	Function	NO	Function
1	power button (on/off)	2	timer control (reduce time)/volume control (reduce volume)
3	timer control (increase time)/volume control (increase volume)	4	temperature control (increase temperture)/ song select control (previous song)
5	temperature control(reduce temperature)song select control (latter song)	6	Fhrenheit sign
7	celsius sign	8	Setting Control
9	lamp light (inside and outside) / song pause	10	blue tooth connected light
11	USB connect interface	12	

Power Button (On/Off) (1)

This button turns the sauna on or off.

Timer Control (2/3)

Use (+) or (-) to increase or decrease the sauna timer. It will count down until 00 and shut down the heaters. The machine stay the FM&MP3 status this two buttons also can be use to increase or decrease the volume .

Continues Working Time

If you would like to keep the sauna working continuously (no time limit), press and hold both (+) and (-) buttons, the display should show two dashes (--). To start the timer again, just click on one of the Timer Control buttons. If the machine working stay the FM status ,press and hold both(+)and(-)buttons the machine will proceed the FM channel search ,this program need to spend 2 minutes and keep all the channels could be seached .

Temperature Control (4/5)

Use the (+) or (-) to increase of decrease the sauna temperature. The heaters will turn off when the sauna reaches its desired temperature. The machine keep the FM &MP3 status these two buttons can be use to select the channels or different songs .

Fahrenheit and Celsius Lights (6/7)

These signs indicate what measurement is used to display the temperature. To switch between Fahrenheit and Celsius, press and hold both Temperature Control buttons.

Setting Control (8)

This button switched between FM and MP3 status .

Lamp and pause button(9)

This button normally use for the turn and off the inside and outside lamps .

But when the machine keep the FM or MP3 status this button can be used to suspend the MP3 or radio press again unlock the pause .

Bluetooth connected light (10)

This sign and the light turn on the machine keep the Bluetooth status that means the machine can be connect to the Bluetooth device for music .

USB connect interface(11)

The hole for the USB insert the machine and keep the MP3 status the music Be played automatically .

Usage Guide

Allow your sauna to warm up for 15-20 minutes or until it reaches 110 F (43 C). You may close the vent on the ceiling to speed up the pre-heating process. Drink plenty of water to avoid dehydration before and after the sauna session. It is recommended not to exceed 40 minutes per session.

If the sauna becomes stuffy, open the vent on the ceiling to allow fresh air into the sauna.

Tip:

- Start using the sauna within 10 degrees before it reaches the set temperature in order to receive the most benefits out of the infrared heaters. For example, if you set the sauna to 125 F (52 C) degrees, you should start using the sauna when it reaches 115 F (46 C) degrees.
- Customers reported an average use temperature of 125 F (52 C) degrees.

Precautions

- If the temperature becomes unbearable, decrease the temperature or shut off the sauna immediately.
- Do not use if pregnant or have serious inflammation, a fever, a communicable disease, acute bleeding, or intoxicated.
- Do not consume alcohol or drugs when using the sauna.
- Do not splash water on the heaters or any electrical component inside the sauna.
- Do not bring wet towels into your sauna or any substances that could harm the interior of your sauna.
- Do not install a lock on your sauna.
- All repairs need to be authorized by the supplier's representative; otherwise product warranty may be voided.

Cleaning and Maintenance

Use a clean damp towel to wipe off the bench, floor and around the back panel. Do not use a towel that is too wet and can drip water inside the sauna and do not use cleaning agents inside the sauna.

Make sure to keep the sauna dry and clean. Do not leave towels or water glasses or bottles inside the sauna after use. Wipe the exterior surface of the sauna with a towel and clean the glass at least once a month.

Wood Care

If the sauna exterior body was scratched or scuffed, it can be concealed by using a small amount of furniture polish, oil or other furniture treatment. The interior blemishes, scratches, or scuffs can be either left alone, sanded or combination of gluing plus sanding. Please avoid any treatment containing benzene or a high concentration of alcohol.

Outdoor models body need to be maintain on regular bases (between 6 months to a year) by polishing or resealing the body as needed. If the varnish is cracked or worn off, sand the surface and re-varnish the affected area. Consult your local handyman or furniture repair professional for more details on how to maintain wood in an outdoor environment.

Sauna's Benefits

Health Benefits

Detoxification and Body Cleansing

Detoxification is a bodily process that transforms health threatening toxic substances from our environment, diets, as well as our own bodies into something harmless or excreted. Sweating is the body's nature way to get rid of harmful toxins and cleansing our bodies through the skin. **The** infrared

sauna waves penetrate deep below the skin to help the body to get rid of toxins buried deep under the skin.

Weight Loss

The Saunas were proven to help a person lose weight and burn calories. According to Journal of the American Medical Association, a sauna session can burn between 300-700 calories. Also, Dr Oz. explained in the Oprah show that an infrared sauna session can burn up to 700 calories.

Pain and Arthritis Relief

The Saunas infrared waves penetrate deep into the muscles for long lasting pain relief. Moreover, patients with rheumatoid arthritis, using an infrared sauna results in a short-term improvement regarding pain and stiffness, reduction in fatigue, and a trend towards long-term beneficial effects.

Skin Purification

In the sauna, skin is cleansed and dead cells are replaced, keeping the skin in good working condition. Sauna heat also relaxes facial tensions, and improves skin elasticity. Sweating rinses bacteria out of the epidermal layer and sweat ducts.

Cardiovascular Workout

Finnish researchers have reported that the regular use of saunas helps maintain the blood vessels in a healthier condition. Vessels become more elastic and pliable longer due to regular dilation and contraction from the process of heating and cooling the body repeatedly.

Lower Blood Pressure and Improved Circulation

Blood vessel dilation brings blood closer to the surface of the skin and, as blood vessels expand to accommodate increased blood flow, circulation in the extremities improves, and the blood pressure gets lower. The effect on the blood pressure is temporary, but medical research shows that frequent sauna bathing can make person's blood pressure level also to stay lower.

DISCLAIMER:

The **Sauna** and its affiliates do not provide medical advice, education or treatment. The information contained in this manual is for general information purposes only and does not address individual circumstances or medical conditions. It may not be right for you and should not be relied upon in making decisions about your health. Always consult your doctor for medical advice.

Saunas and Contraindications

Saunas and Medications

Individuals who are using prescription drugs should seek the advice of their personal physician or a pharmacist for possible changes in the drugs effect when the body is exposed to far infrared waves or elevated body temperature. Diuretics, barbiturates and beta-blockers may impair the body's natural heat loss mechanisms. Some over the counter drugs such as antihistamines may also cause the body to be more prone to heat stroke.

Saunas and Children

The core body temperature of children rises much faster than adults. This occurs due to a higher metabolic rate per body mass, limited circulatory adaptation to increased cardiac demands and the inability to regulate body temperature by sweating. Consult with the child's Pediatrician before using the sauna.

Saunas and the Elderly

The ability to maintain core body temperature decreases with age. This is primarily due to circulatory conditions and decreased sweat gland function. The body must be able to activate its natural cooling processes in order to maintain core body temperature.

Saunas and Cardiovascular Conditions

Individuals with cardiovascular conditions or problems (hypertension / hypotension), congestive heart failure, impaired coronary circulation or those who are taking medications, which might affect blood pressure, should exercise extreme caution when exposed to prolonged heat. Heat stress increases cardiac output, blood flow, in an effort to transfer internal body heat to the outside environment via the skin (perspiration) and respiratory system. This takes place primarily due to major changes in the heart rate, which has the potential to increase by thirty (30) beats per minute for each degree increase in core body temperature.

Saunas and Alcohol

Contrary to popular belief, it is not advisable to attempt to "Sweat Out" a hangover. Alcohol intoxication decreases a person's judgment; therefore they may not realize it when the body has a negative reaction to high heat. Alcohol also increases the heart rate, which may be further increased by heat stress.

Saunas and Chronic Conditions / Diseases Associated With a Reduced Ability to Sweat or Perspire

Parkinson's, Multiple Sclerosis, Central Nervous System Tumors and Diabetes with Neuropathy are conditions that are associated with impaired sweating.

Saunas and Hemophiliacs / Individuals Prone To Bleeding

The use of Infrared saunas should be avoided by anyone who is predisposed to bleeding.

Saunas and Fever

An individual that has a fever should not use any type of sauna.

Saunas and Insensitivity to Heat

An individual that has insensitivity to heat should not use any type of sauna.

Saunas and Pregnancy

Pregnant women should consult a physician before using any type of sauna because fetal damage can occur with a certain elevated body temperature.

Saunas and Menstruation

Heating of the low back area of women during the menstrual period may temporarily increase their menstrual flow. Some women endure this process to gain the pain relief commonly associated with their cycle whereas others simply choose to avoid saunas use during that time of the month.

Saunas and Joint Injury

If you have a recent (acute) joint injury, it should not be heated for the first 48 hours after an injury or until the hot and swollen symptoms subside. If you have a joint or joints that are chronically hot and swollen, these joints may respond poorly to vigorous heating of any kind. Vigorous heating is strictly contra-indicated in cases of enclosed infections be they dental, in joints or in any other tissues.

Saunas and Implants

Metal pins, rods, artificial joints or any other surgical implants generally reflect far infrared waves and thus are not heated by this system; nevertheless you should consult your surgeon prior to using an Infrared Sauna. Certainly, the usage of an Infrared Sauna must be discontinued if you experience pain near any such implants. Silicone does absorb far infrared energy. Implanted silicone or silicone prostheses for nose or ear replacement may be warmed by the far infrared waves. Since silicone melts at over 200°C (392°F), it should not be adversely affected by the usage of Infrared saunas. It is still advised that you check with your surgeon and possibly a representative from the implant manufacturer to be certain.

In the rare event, you experience pain and/or discomfort, immediately discontinue sauna use.

Troubleshooting

The sauna doesn't power on

- Make sure the power cord is securely connected to the power socket and the control box (on top of the sauna).
- Make sure the breaker did not turn off.
- Make sure the control panel white ribbon wire is securely connected.
- Make sure the power socket is working by trying a different device on the same socket.

Light is not working

- Replace the light bulb.

Color therapy light does not work

- Make sure the battery is inserted correctly.
- Make sure to point the remote directly at the remote receiver (small rounded tip next to the color lights).
- Try a new battery.

All heaters are not working

- Make sure to connect the heaters plugs are connected securely to the control box (on top of the sauna).
- Make sure the sauna is connected to the recommended power supply.
- Make sure the heat sensor is connected securely.

One or few heaters are not working

- Make sure to connect the heaters plugs are connected securely to the control box (on top of the sauna).
- Make sure to connect the heaters plugs under the bench are connected securely.

- Floor heater and under bench heater are not as hot as other heaters (by design).
- Make sure the plug behind the heater is connected (you would need to unscrew the heater).

Control panel display is unusual

- If the control panel temperature display is over 150 or 230, make sure to connect the heat sensor securely.
- If the control panel time display is -- (two dashes), the sauna is on continues working mode. Press the timer button to return to timed working mode.

CD player is not working

- If the CD refuses to play, try a different CD. Copied or burned CDs must be finalized.
- If the radio has a bad reception, extend the antenna outside the sauna roof.
- If the USB cannot read an MP3 player, use an Aux-In plug and play the music from the MP3 player.

For more troubleshooting advice or to report a problem, please contact with the supplier

Warranty Information

The **Sauna** warrants its products to be free of defects in material and workmanship.

This warranty extends only to:

1. a retail purchaser of a sauna or parts directly from **the supplier**;
2. the authorized wholesale purchaser of a sauna or parts directly from **the supplier** ; or

3. a retail purchaser of a sauna or parts from **the supplier** authorized wholesaler.

However, in the event of a sale, transfer or conveyance of a sauna or parts from any of the three (3) preceding persons or entities, any rights, duties and obligations associated with this warranty shall be null and void and of no further force and effect. The sauna or parts must be purchased and used within one year of the manufactured date.

The sauna or parts must be placed in an indoor environment unless the sauna or parts are specifically designed for outdoor use. If an indoor sauna or parts are placed in an outdoor environment, warranty shall be null and void and of no further force and effect. The controls, heaters, electrical parts and wiring must be kept dry at all times and not exposed to any water or liquids.

Residential Use:

Indoor Models Parts: Lifetime warranty on wood, controls and heaters. CD player warranty is limited to one (1) year.

Outdoor Models Parts: Lifetime warranty on controls and heaters. Wood, outdoor cover and CD player warranty is limited to one (1) year.

Labor: One (1) year labor.

Freight & Shipping: One (1) year on replacement part only.

Commercial Use:

Indoor Models Parts: One (1) year warranty on wood, controls and heaters. CD player warranty is limited to six (6) months.

Outdoor Models Parts: One (1) year warranty on controls and heaters. Wood, outdoor cover and CD player warranty is limited to six (6) months.

Labor: Six (6) months labor.

Freight & Shipping: Six (6) months on replacement part only.

The warranty begins on the original date of purchase, and is valid only on products purchased and used in the pointed market. To receive warranty service, the purchaser must contact **the supplier** for problem determination

and service procedures. Warranty service can only be performed by **the supplier** authorized service center. The original dated bill of sale must be presented upon request as proof of purchase to **the supplier** or **the supplier authorized** service center.

In-home service will be provided during the warranty labor period subject to availability within the contiguous United States or Canada. In-home service is not available in all areas. To receive in-home service, the product must be unobstructed and accessible from floor level to service personnel. If during in-home service repair cannot be completed, it may be necessary to remove, repair and return the product. If in-home service is unavailable, **the supplier** may elect, at our option, to provide for transportation of our choice to and from the **supplier** authorized service center. Otherwise, transportation to and from the **supplier** authorized service center is the responsibility of the purchaser.

This warranty covers manufacturing defects in materials and workmanship encountered in normal use of this product, and shall not apply to the following, including, but not limited to: damage which occurs in shipment; delivery and installation; applications and uses for which this product was not intended; altered product or serial numbers; cosmetic damage or exterior finish; accidents, abuse, neglect, fire, water, lightning or other acts of nature; use of products, equipment, systems, utilities, services, parts, supplies, accessories, applications, installations, repairs, external plumbing and leaks, external wiring, circuit breakers, fuses or connectors not supplied and authorized by **the supplier**, or which damage this product or result in service problems; incorrect electrical line voltage, fluctuations, and surges; customer adjustments and failure to follow operating instructions, cleaning, maintenance and environmental instructions that are covered and prescribed in the instruction book; consumable items including light bulbs.

The Sauna shall not be liable for the loss of use of the sauna or other incidental or consequential damages. Under no circumstances shall **the supplier** or any of its representatives be held liable for injury to any persons or damages to any properties. Specifications are subject to change without notice.

The sauna uses the highest quality wood in our product lines. All structures using wood are susceptible to minor dents, scratches and scuffing. This is normal and will not affect the integrity or operation of your sauna.

Wood is a living material that continues to respond to climate conditions, even after being manufactured into a sauna. Variations in the color or grain, and irregularities such as fine cracks are part of the natural beauty of the wood and in no way should be considered defects. During normal operation, wood may crack slightly due to the changes in moisture level. This will not affect the structural integrity of the sauna.

Prior to shipping, the wood is inspected for consistency, color and quality. Our saunas are shipped around the globe, and can experience slight blemishes, scratches or scuffs in transit. In most cases, these blemishes on the exterior of the sauna can be concealed by using a small amount of furniture polish, oil or other furniture treatment. The interior blemishes, scratches, or scuffs can be either left alone, sanded or combination of gluing plus sanding. Please avoid any treatment containing benzene or a high concentration of alcohol.

ATTENTION: Shipping damage must be notated on the Bill of Lading (BOL). **The Supplier must** be notified of any damage to your sauna within three (3) business days of signing the BOL. Failure to notify **the supplier** within the established time frame will result in the owner taking full responsibility for cost of ALL REPLACEMENT PARTS including shipping and handling fees.